

TL30.70

Urządzenia teleskopowe

Dane techniczne

Performance

Rated capacity	3000 kg
Capacity (at max. height on tyres)	2000 kg
Capacity at max. reach	1050 kg
Lifting height	6675.0 mm
Tilt Breakout force	4600 daN
Drawbar pull	4900 daN
Max. reach	4020.0 mm

Czas cyklu

Boom raising	5.3 s
Boom lowering	4.0 s
Boom extension	6.3 s
Boom retraction	4.2 s
Crowding	2.5 s
Dumping	2.4 s

Weights

Masa własna (20-calowe opony)	5564 kg
Masa własna (24-calowe opony)	5684 kg

Engine

Make / Model	Bobcat D34
Fuel	DIESEL
Rated power (ISO 14396)	74.0 kW
Rated speed	2400.0 RPM
Maximum torque at 1400 rpm	430.0 Nm
Number of cylinders	4.0
Displacement	3.41 L

Hydraulic system

Pump type	Gear pump with LS valve
Pump capacity	100.00 L/min
Relief valve pressure setting	250.00 bar
Control valve type	Open center with flow sharing & flow compensators technology

Drive system

Transmission	Hydrostatic with electronic regulation
Main Drive	Hydrostatic motor

Traction

Standard Tyres	405/70-20 16PR TM R4
Max speed - turtle mode (24" / 20")	10 / 8,5
Max speed - rabbit mode (24" / 20")	31 / 26,5
Max speed - turtle mode (24" / 20") - (Option high speed)	10 / 8,5
Max speed - rabbit mode (24" / 20") - (Option high speed)	40 / 35

Brakes

Engine Braking	Hydrostatic
Parking and Emergency brake	Passive brake
Service Brake	Oil immersed discs

Steering

Steering Mode	2 wheel steering / 4 wheel steering / Crab-steering
---------------	---

Fluid Capacities

Fuel tank	115.00 L
Adblue ® tank	22.40 L
Hydraulic tank	47.00 L
Hydraulic system	88.00 L

Ochrona środowiska

Operator noise level (LpA) (EN 12053)	76 dB(A)
Level of acoustic power (LwA)	106 dB(A)
Drgania przenoszone na całe ciało (EN 13059)	1.80 ms ⁻²

Dimensions

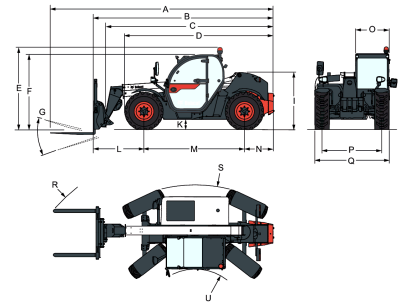

Values marked with * - 24" tyres

(A)	6240.0 mm	(K*)	348.0 mm
(B)	5035.0 mm	(L)	1400.0 mm
(C)	4670.0 mm	(M)	2820.0 mm
(D)	4185.0 mm	(N)	818.0 mm
(D*)	4273.0 mm	(O)	930.0 mm
(E)	2440.0 mm	(P)	1666.0 mm
(E*)	2524.0 mm	(Q)	2100.0 mm
(F)	2290.0 mm	(R)	5035.0 mm
(F*)	2375.0 mm	(R*)	5135.0 mm
(G)	136.0°	(S)	3717.0 mm
(I)	1587.0 mm	(S*)	3875.0 mm
(I*)	1671.0 mm	(U)	1329.0 mm
(K)	264.0 mm	(U*)	1503.0 mm

Load Charts

Load Charts

